

# Eliminator Jr. H/O Ionizer with Emitter Cassette Installation, Operation and Maintenance

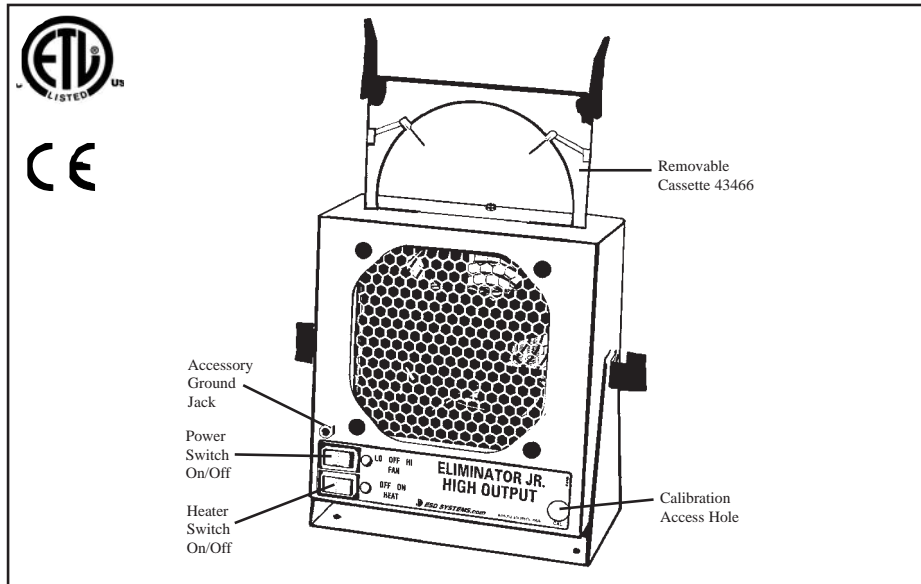

**Figure 1. Eliminator Jr. H/O (High Output) Ionizer**

## Description

Our Eliminator Jr. H/O Ionizer is a compact and lightweight auto-balancing bench top Ionizer with emitter cassette. The emitter cassette slides out easily for cleaning and replacement. The Eliminator Jr.'s unique active feedback balancing circuit automatically ensures and maintains the unit's ion balance despite variations in line voltage, air speed, or emitter electrode condition. The Ionizer's feedback circuit also gives a visual alarm indication when maintenance is required. The unit's compact, efficient design minimizes bench top space requirements and need for maintenance, while maximizing neutralization efficiency and overall performance.

Ionizers are useful in preventing electrostatic charge generation, ElectroStatic Discharge, ElectroStatic Attraction, as well as preventing equipment latch-up and safety related shock. ANSI/ESD S20.20 Paragraph 6.2.3.1 Protected Areas Requirement states: "Ionization or other charge

mitigating techniques shall be used at the workstation to neutralize electrostatic fields on all process essential insulators if the electrostatic field is considered a threat." Ionization is used to neutralize charges on process necessary insulators and isolated semiconductors. Some examples of process necessary insulators are: the PC board itself, plastic test stands, plastic housing where a PCB may be mounted, as well as computer monitor screens and regular cleaning wipes. Examples of floating or isolated conductors are: loaded PCB mounted in a stand where the pins are not contacting the dissipative workstation. Ionization is not effective on items that have large capacitance, like people and carts; however, ionizers should be considered as a method for charge neutralization in cases where grounding cannot be achieved.

Air ionization can neutralize the static charge on insulated and isolated objects by producing separate charges in the molecules of the gases of the surrounding air. When an electrostatic charge is present on objects in the work

environment, it will be neutralized by attracting opposite polarity charges from the ionized air. Note that ionization systems should not be used as a primary means of charge control on conductors or people. (Reference: IEC 61340-5-2:1 paragraph 5.2.9).

The Eliminator Jr. H/O Ionizer is available in 3 models.

Item #	Voltage	Heater	NIST
43161	120 Volt	No	Yes
43162	120 Volt	Yes	Yes
43163	220 Volt	No	Yes

All models come equipped with universal IEC cord connectors and removable emitter cassettes.

## IONIZER SELECTION

ANSI/ESD S20.20 paragraph 6.1.1.2. ESD Control Program Plan Guidance states: "The Plan should include a listing of the specific type of ESD protective materials and equipment used in the Program." When selecting an ionizer life cycle costs should be considered including: equipment cost; installation cost; and operation and maintenance cost.

The unit is normally placed at one end of a workbench or area to be neutralized. It may also be wall mounted or mounted on a shelf.

The Ionizer's decay time (neutralization efficiency) will be best from approximately 6" to 42" in front of the unit, and will drop off as the distance from the unit increases.

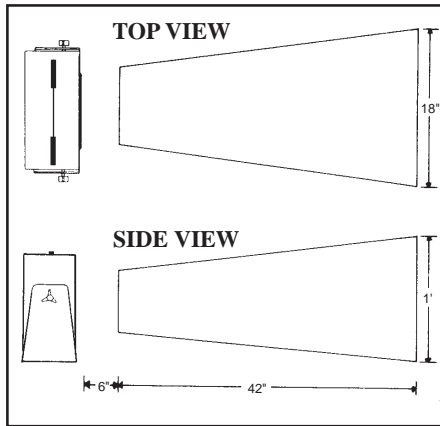

**Figure 2. Area of optimum charge neutralization**

## Installation

Remove the Ionizer from the carton and inspect for damage. Included with the unit should be:

- 1 air filter
- 1 stand assembly with hardware
- 1 power cord (120 Volt only)

Mount the unit in the desired position. Set the front panel rocker switch to the "off" or mid position.

Install the power cord into an appropriate power source. Eliminator Jr. models 43161 and 43162 operate on 120 VAC 50/60 Hz., while model 43163 operates on 220 VAC 50/60 Hz. The Ionizer must be connected to a properly grounded receptacle for operation.

## Installing Stand Assembly

To install the stand assembly follow the instructions shown in Figure 3. You can mount the unit on a bench top or remove the rubber feet and bolt the stand to a wall or under a shelf as desired. Be sure to use appropriate fasteners. For best results, mount the unit so that no obstructions exist either on the intake or the outlet side.

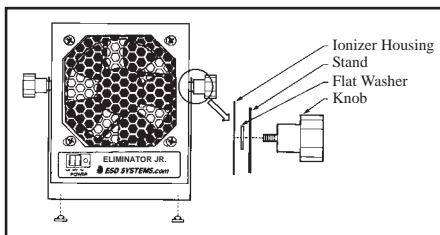
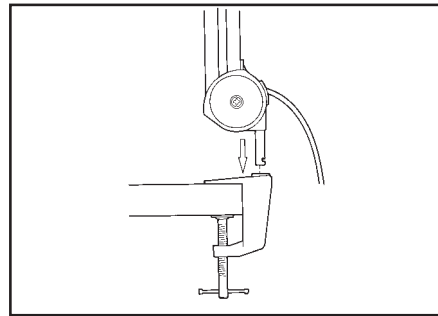

**Figure 3. Installing stand assembly**

## Alternative Mounting

The optional 43155 Ionizer Mounting Arm is designed as a mounting alternative for the Eliminator Jr. Ionizer. The 43155 allows a Jr. Ionizer to be mounted off the bench top, saving valuable work bench space. The articulated movement of the arm assembly allows the user to precisely focus the Ionizer's output directly onto the desired areas or across the entire work area.

The Ionizer Mounting Arm includes a C-clamp style mounting system for ease of installation. Figure 4 shows proper mounting of the arm on a workbench. The arm also includes an installed three prong power cord with an IEC termination.



**Figure 4. Installing mounting arm on workbench.**

The arm's custom neck piece allows for easy mounting of a standard Jr. Ionizer via the stand assembly. The ionizer should be mounted to the arm by tightening the bolt onto the neck piece as shown in Figure 5.

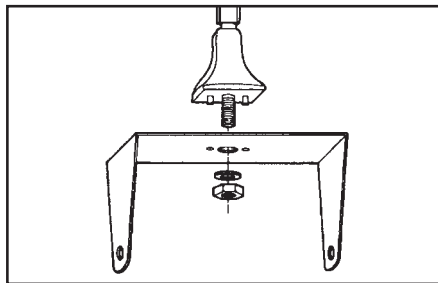

**Figure 5. Installing Eliminator Jr. to Ionizer Mounting Arm**

The 43155 is sold separately. For detailed information on the installation and operation of the 43155 Ionizer Mounting Arm, ask for Tech Brief PS-2047.

## Operation

For 43161 and 43163 set the front panel rocker fan switch to either "HIGH" or "LOW" fan speed. Higher air flow will result in a faster neutralization rate.

**Safety interlock switches are provided internally on the emitter cassette. This insures that power is cut off in the event that the cassette is removed or not fully installed.**

Aim the unit so that the maximum airflow is directed at the items or area to be neutralized. The bottom rocker switch on the 43162 turns on a heater which will raise the temperature of the output air to about 10°F above ambient. The heater is only to offset the chill factor of the moving air. It is not intended to warm the workstation.

**If the ionizer is used in a manner not specified by the manufacturer, the protection provided by the ionizer may be impaired.**

## Maintenance

"As with all ionizers, periodic maintenance will be needed to provide optimum performance." (Reference: IEC 61340-5-2:1 paragraph 5.2.9).

The frequency of monitoring ionizers really depends on how and where they are used. Since the majority of them use a fan to transport the ions to the working area, the cleanliness of the air directly affects their performance over time and how often the emitters should be cleaned.

EIA-625 recommends checking ionizers every 6 months, but this may not be suitable for many programs particularly since an out-of-balance may exist for months before it is checked again. Junior Ionizers have a very desirable feature, as they will provide visual and audible alarms when an out of balance exists. ANSI/ESD S20.20 paragraph 6.1.3.1 Compliance Verification Plan Requirement states: "Test equipment

shall be selected to make measurements of appropriate properties of the technical requirements that are incorporated into the ESD program plan." And paragraph 6.1.3.2. Compliance Verification Plan Guidance states: "In addition to internal audits, external audits (Organization and supplier of ESDS items) should be performed to ensure compliance with planned requirements. Verifications should include routine checks of the Technical Requirements in the Plan. The frequency of verification checks should be based on the control item usage, its durability and associated risk of failure."

Under normal conditions, the ionizer will attract dirt and dust (especially on the emitter electrodes). To maintain optimum performance, cleaning **must** be performed on a regular basis. The electrodes should be cleaned at least every six months. However, more frequent cleaning may be required if used in environments with more contaminants.

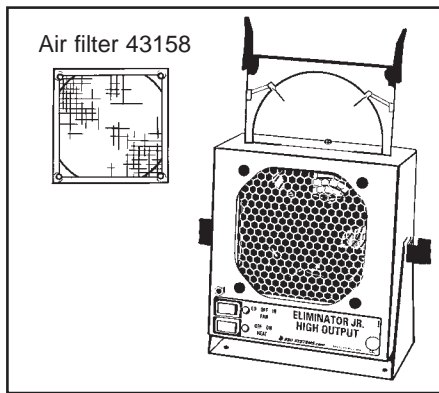

**Figure 6. Removable emitter cassette**

By their nature, all electric ionizers attract contaminants to the high voltage emitter pins. For best performance, this contamination must be kept to a minimum. This was a major factor in the design process of the Jr. ionizer with emitter cassette. Although we could not eliminate the maintenance, we have made it far easier to quickly and more thoroughly clean the emitters than ever before.

- Switch to the OFF position.
- Grasp the emitter cassette ejector levers at the center and pivot outward about 90 degrees.

- Grasping the right and left corners, pull the emitter cassette straight out of the Ionizer.
- The emitter cassettes can then be replaced with a spare set and/or removed to another area for cleaning.
- Emitter pins are readily accessible and the cleaning of the emitter cassette can be accomplished with a stiff brush or lint-free swab and isopropyl alcohol or other residue-free cleaning solvent.

**Note:** An air filter is included with the unit to be used in place of the unit's grill in dusty or dirty environments. The air filter will reduce the frequency of cleaning necessary for the unit. Performance will be somewhat compromised due to air flow restriction. To install air filter, remove the four Phillips screws and install screen. The dimensions of the screen are 4-5/8" x 4-5/8" x .15". Construction is 30x30 aluminum mesh (30 wires/sq. in. in a crisscross pattern). This filter is easily removed and can be washed in warm, soapy water when it becomes dirty. Replacement filters are available.

### Neutralization Efficiency (Decay Time)

The comparative efficiency of bench top ionizers is determined by ESD Association Standard S3.1. The ion emitter electrodes produce a high ion output for rapid charge dissipation. The decay rates measured using this standard for the ionizer are shown in Figure 9. The performance of the ionizer was measured with the unit positioned at varying distances with the fan speed on high and without a filter.

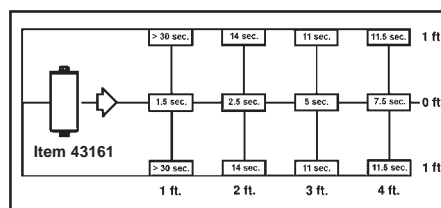

**Figure 7. Decay time in seconds from +1000 volts to +100 volts on a 6" x 6" charged plate per EOS/ESD-S3.1**

### Theory of Operation

By definition, materials that are insulators cannot have static charges removed via grounding as they do not conduct electricity. Ionizer emitters flood an area with millions of positive and negative charged electrons to neutralize statically charged insulators.

The Eliminator Jr. employs a safe non-nuclear Steady-State DC ionization source. Steady D.C. systems consist of separate negative and positive ion emitters connected by a pair of high-voltage cables to their respective high-voltage power supplies. The spacing between emitters varies depending on the design, and D.C. power is constantly applied to the emitter points. The ionizer's unique, closed loop monitoring circuitry monitors ion output and automatically adjusts the unit to reach an equilibrium at perfectly balanced ion flow. The ionizer is designed to achieve balance under extreme conditions and is uniquely able to maintain balance in almost any environment. ESD Systems.com ionizers meet the ANSI/ESD S20.20 minimum recommended technical requirement range of less than  $\pm 50$  volts voltage offset tested in accordance with ANSI EOS/ESD S3.1. Eliminator Jr. Ionizers greatly exceed the requirement providing  $\pm 5$  volt auto balancing.

The unit's circuitry also features a visual alarm, which alerts the user to out of balance conditions caused by excessive electrode contamination or the failure of either the positive or negative power supply. When the Eliminator Jr. is ON and its output is balanced, the blue LED indicator on the front of the unit will be steadily lit. If an out of balance condition is detected the balance circuit will cause the blue LED to flash until the problem is corrected. See the maintenance section for recommended maintenance procedures. This feature safeguards that the ionization is balanced, protecting sensitive components and assemblies from being exposed to harmful charging from an out of balance ionizer.

The Eliminator Jr.'s quiet and gentle fan is designed so that it will not disturb personnel, paperwork, or delicate parts. The LED indicator mounted on the face of the unit allows the operator to easily verify whether it is ON, OFF, or in need of maintenance. The Ionizer's emitter electrode material will not require replacement during the normal life of the product.

The Eliminator Jr. is engineered for efficiency and durability. The unit's automatic feedback balancing circuitry eliminates the need for repeated calibration, making this Ionizer highly dependable and cost effective.

## Specifications

### Input:

43161	120 VAC - 50/60 Hz, 200 mA
43163	220 VAC - 50/60 Hz, 150 mA
43162	120 VAC - 50/60 Hz, 2.0 Amps

### Fuse Type:

43161	Fast Blow 1 amp
43163	Fast Blow 1 amp
43162	Slow blow 3 amps

Ozone: Less than 0.05ppm

Airflow: Dual speed, 77 CFM maximum

Weight: 4 Pounds

### Cord:

43161	IEC cord set
43163	No power cord
43162	IEC cord set

### Dimensions:

Without Stand:	6.7" x 6.6" x 3.5"
With Stand:	8.5" x 7.75"
Base:	6.8" x 3.4"
Holes:	0.122" in diameter, in a 5.83" x 2.4" rectangular pattern

## Testing and Calibration

Ionizers are tested and calibrated using a charged plate analyzer. For proper testing, we recommend a charged plate analyzer and the procedure outlined in ESD Standard S3.1. This standard may be purchased from the ESD

Association, 7902 Turin Rd., Suite 4, Rome NY 13440-2069, (315-339-6937). If you have access to a charged plate analyzer, you can use it to calibrate the Eliminator Jr. We will be happy to send you information on our model 94052 Charged Plate Analyzer.

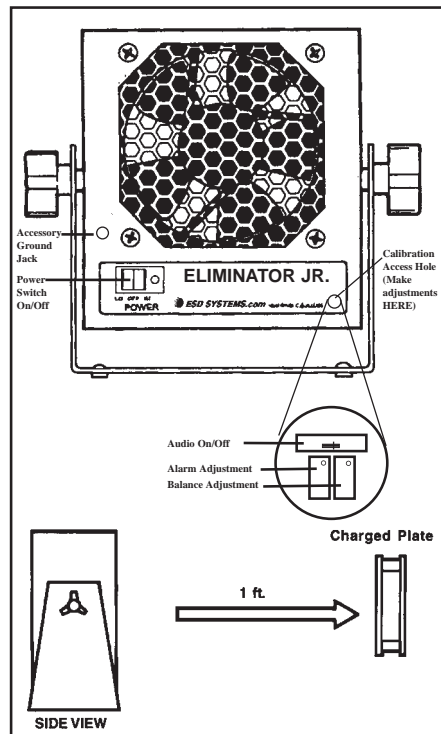

**Figure 8. Calibration and position of charged plate for calibration.**

Calibration traceable to National Institute of Standards and Technology (NIST) is a standard feature of all Models.

## Adjustment

For Audio On/Off and Alarm and Balance Adjustment see Figure 8.

## Health

There are no known health risks associated with our devices. The emitters work at about 4-6 kV and can create ozone, but there have been no significant measurement of ozone from our emitter sets, as all our existing units test well below the OSHA limit of 0.05 ppm ozone. For additional safety information, see "Dispelling an Old Myth" written by William Metz of Hewlett-Packard published in Evaluation Engineering magazine, September 2001.

## LIMITED WARRANTY

ESD Systems.com expressly warrants that for a period of one (1) year from the date of purchase, ESD Systems.com Eliminator Jr. H/O's will be free of defects in material (parts) and workmanship (labor). Within the warranty period, the unit will be tested, repaired or replaced at our option, free of charge. Call Customer Service at 508-485-7390 for a Return Material Authorization (RMA) and proper shipping instructions. You should include a copy of your original packing slip, invoice, or other proof of purchase date. Any unit under warranty should be shipped prepaid to the ESD Systems.com factory. Warranty repairs will take approximately two weeks.

If your unit is out of warranty, ESD Systems.com will quote repair charges necessary to bring your unit to factory standards. Call Customer Service at 508-485-7390 for a Return Material Authorization (RMA) and proper shipping instructions and address.

## WARRANTY EXCLUSIONS

THE FOREGOING EXPRESS WARRANTY IS MADE IN LIEU OF ALL OTHER PRODUCT WARRANTIES, EXPRESSED AND IMPLIED, INCLUDING MERCHANTABILITY AND FITNESS FOR A PARTICULAR PURPOSE WHICH ARE SPECIFICALLY DISCLAIMED. The express warranty will not apply to defects or damage due to accidents, neglect, misuse, alterations, operator error, or failure to properly maintain, clean or repair products.

## LIMIT OF LIABILITY

Electronic ionizers use high voltage corona discharge and should not be used in or near flammable or explosive environments. In no event will ESD Systems.com or any seller be responsible or liable for any injury, loss or damage, direct or consequential, arising out of the use of or the inability to use the product. Before using, users shall determine the suitability of the product for their intended use, and users assume all risk and liability whatsoever in connection therewith.



Visit our online  
library of Tech Briefs:  
<http://www.esdsystems.com/>

**ESD SYSTEMS.com**

432 NORTHBORO ROAD CENTRAL  
MARLBORO, MA 01752-3170  
PHONE (508) 485-7390  
FAX (508) 480-0257